

Solutions For Growing the Power Factor Prevent A Reactive Electricity Tariff And Decrease Warmth On Installation With Bank Capacitors

Anggara Trisna Nugraha^{1*}, Muhammad Syahid Messiah², Dimas Rinaldi³, Moch Fadhil Ramadhan⁴, Muhammad Jafar Shiddiq⁵

^{1,3}Marine Electrical Engineering Shipbuilding Institute of Polytechnic Surabaya
Jl. Teknik Kimia Keputih Sukolilo, Surabaya 60111, Indonesia
^{1*}anggaranugraha@ppns.ac.id

^{2,4,5}Automation Engineering Shipbuilding Institute of Polytechnic Surabaya
Jl. Teknik Kimia Keputih Sukolilo, Surabaya 60111, Indonesia

Article history:

Received 9 May 2021
Revised 29 June 2021
Accepted 23 July 2021
Available online 31 July 2021

Keywords:

Capasitor Bank
Cos ϕ
Motor
Resistance

Abstract

PT. Intan Ustrix that's placed at Jl. Raya Roomo No.425, Sekarsore, Roomo, Kec. Manyar, Kabupaten Gresik Indonesia is a company engaged in the paper and cardboard business, and has many machines used in the manufacturing process. The load of the induction motor will make the cost lower, thereby increasing the current cost through the device inside the carton production unit. Fixing the cost of cos is a great way to solve this problem. In this case, it is very important to install a capacitor bank to recover the charge. By installing a capacitor bank will affect the overall performance of the motor used. The cause of this research is the increasing cost of boarding at the cardboard production unit of PT. Intan Ustrix. As an evaluation, capacitor banks are installed on the H200, AFG, 6PA, FM, and 6PS buses so that low cos costs can be increased. The final result of this charge shows that increasing the cos cost at full load of 325 KW from 0.716 to 0.872 can reduce the actual power cost (S) from 396 KVA to 329 KVA, which can maintain 65 KVA and today's decrease (I) from 498 A to 410 A, the lower the current consumption price of the motor used can increase the resistance of the device to the carton production unit.



This is an open access article distributed under the Creative Commons Attribution License, which permits unrestricted use, distribution, and reproduction in any medium, provided the original work is properly cited. ©2021 by author.

I. INTRODUCTION

PT. Intan Ustrix that is placed at Jl. Raya Roomo No.425, Sekarsore, Roomo, Kec. Manyar, Gresik Regency is a producing industry [1]. Industrial manufacturing facilities are placed withinside the paperboard and paperboard manufacturing section [2]. Cardboard packing containers are of path one of the middle merchandise of the packaging industry. But it's smooth to overlook that the card packing containers you operate on a normal foundation have been as soon as a not-so-humble tree. Kite Packaging have grilled its technologists to inform us precisely what the system is for cleansing the uncooked substances and

^{1*} Corresponding author

processing them to make the card packing containers you purchase each day for your business.

The carton manufacturing unit includes six buses (1 bus is one manufacturing system), specifically H200, AFG, 6PS, FM, 6PA, and finishing. Since the motor load is inductive, the cost of $\cos \phi$ decrease, increasing the cost of the modern fed on via way of means of the system withinside the carton manufacturing unit and impacts the overall performance and sturdiness of the system motor [4]. As consistent with FICCI, cardboard merchandise make up extra than 30% of the packaging industry. Due to this fact, corrugated packing containers are quite popular. Regular slotted containers, for example, are one of the maximum extensively used varieties of packing containers for delivery and storage. Corrugated cartons are low-cost, durable, and eco-friendly. However, now no longer all packing containers are made equal. That is to say, and they range loads in phrases of compressive power, thickness, chemical resistance, and different factors.

You'll want to recognize this if you have to pick out an appropriate corrugated container for your packaging needs. The cardboard power and production at once affect the quantity of weight a container can carry. A container too susceptible would possibly puncture or collapse. On the alternative hand, you pay more for cloth and upload to environmental wastage in an immoderate container manner.

As an assessment, it's far important to boom the cost of $\cos \phi$ via way of means of putting in a capacitor financial institution on every bus bar withinside the carton manufacturing unit of PT. Ustrix [5]. Installing this capacitor financial institution will affect the overall performance and resistance of the motor used [6]. In this study, the capacitor financial institution capability turned into decided using the Etap 7.0.0 software [7].

II. METHODS

A. Testing Methods

a) Bursting Strength Test

The Mullen Test or Bursting Strength Test tests the durability of the partitions of the corrugated board while subjected to pressure or strain. In this trying-out procedure, a rubber diaphragm is used to use strain to the partitions of the corrugated field till it bursts. The diaphragm has multiplied the usage of hydraulics, and because the diaphragm expands, the corrugated board bursts beneath neath strain. We degree the bursting energy in Kilograms in line with rectangular centimeters. The Bursting thing is given as one thousand instances of the bursting energy, divided through the grammage of the board.

$$\text{Bursting factor} = \text{Bursting strength (kg/cm}^2\text{)} \times 1000/\text{Grammage (gm/m}^2\text{)}$$

b) Edge Crush Test

The effects of the Edge Crush take a look at our measured in kilos in step with a lineal inch of load-bearing part, however, represented as ECT. ECT offers you a correct concept of a field's power whilst they're stacked and shipped with the aid of using pallets. Also, an ECT-rated corrugated field makes use of much less fabric than its equal Burst Test rated field to offer an equal stage of power. This way it's inexpensive and much less wasteful to buy ECT-rated bins in bulk. However, it's far critical to understand that the above effects (average power of a field) can also add range primarily based totally on the make-up of every corrugated sheet. Hence, understanding the kind of corrugation is critical earlier than you are making a decision.

c) Water Resistance of the Gluing

Even eleven through the fiberboard itself can take in and preserve water. Checking out the water-resistance of gluing or sealing is likewise essential. For sure applications, the corrugated board is immersed in water in this sort of test whilst exposing the glue strains to test for bond electricity and water absorption.

d) Cobb Sizing Tester

The uncooked fabric used withinside the manufacture of corrugated fiberboards has a bent to soak up water and keep it. The Cobb Sizing tester is used to the diploma to which water is absorbed. In this check,

corrugated fiberboard is first subjected to water. Then, the water is squeezed out of the pattern by the use of pressure. Usually, relying on the quality, all the water isn't always eliminated despite the board being pressed with the aid of using a heavy metal roller. The distinction in weight due to the retained water is called the Cobb fee. The decrease the Cobb fee, the higher the water resistance. The Cobb check is needed for sure certifications, particularly the ones related to unsafe fabric packaging.

e) Paper Grammage and Thickness

Grammage and thickness are the two maximum essential houses of the corrugated fiberboards that decide the nice of the container. There is no "Best" grammage or thickness referred to in corrugated containers specs, and it's far absolutely primarily based totally on your requirements. When more significant padding is required, a container with a better thickness is used. The flutes of the corrugated board are large and have greater air in them. Thin forums with dense flutes have an excessive grammage. Such containers are wanted whilst the packaging must be greater compact and rigid.

f) Puncture Resistance

Puncture resistance checks how nicely the container can manage the effect made with a pyramid or triangularly fashioned weight.

g) Scuff Resistance Test

For this purpose, scuff resistance or rub evidence assessments are employed. There is the Sutherland Rub Test, that's an industry-trendy trying-out procedure. Coated surfaces inclusive of paper, films, paperboards, and all different revealed substances are examined using this procedure.

Alternative corrugated field trying out techniques also are to be had to check resistance to abrasion. These consist of rotary abrasion testers or even guide wiping. Scuff Resistance take a look at is particularly vital for pharmaceutical or scientific industries in which label legibility is of high importance.

h) Box Compression Test

Box compression takes a look at, additionally referred to as field compression take a look at, is a manner to check how a good deal loads the field can tackle pinnacle of it earlier than it receives deformed and the quantity to which it receives deformed. It offers us an awesome concept of what number of containers may be stacked collectively without adverse the contents of the lowermost field. It takes a look at is essential to test the energy of containers and is needed with the aid of using maximum industries transporting containers in bulk.

i) Chemical Analysis in Corrugated Box Testing

Chemical evaluation is needed for positive programs in which the character of fiberboard, in addition to its resistance to positive chemicals, is checked. The evaluation of the fiberboard includes a microscopic exam of the board to look at what forms of paper are used to make the fiberboard. Moreover, the moisture content, in addition to the pH of the board, is likewise determined.

B. Research Stages Methods

a) Research Flowchart

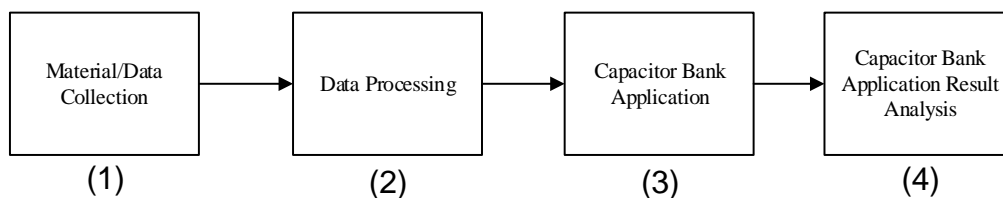

Figure 1. Research Flowchart

b) Data retrieval

All device load records are used to decide the preliminary situation of the carton manufacturing unit of PT. Intan Ustrix.

c) Capacitor Bank Installation

It is used to catch up on the reactive electricity generated through the capacitive traits of the capacitor beneathneath inductive loads [8].

- Determination Cos φ [9]

The power in a three-phase system is the same, both the Y and Δ relations apply the equation as below [10]:

$$P = \sqrt{3}.V.I.\cos\varphi$$

Where :

- Cos φ = Power Factor
- P = Power (Watt)
- V = Voltage (Volt)
- I = Current (Ampere)

- Power Factor Improvement [11]

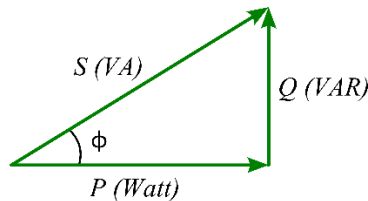

Figure 2. Power Triangle

$V.I.\cos\varphi$ is the total active power (P total) at full load operation then: Reactive Power (Q) [12].

$$Q = \sqrt{S^2 - P^2} = S.\sin\varphi = P.\tan\varphi$$

To boom the price of $\cos\varphi_2$ near the precise price, particularly 1 (Unity Power thing) [13]. By searching on the fluctuating load characteristics, the intention of enhancing the strength thing for the carton manufacturing unit of PT. Intan Ustrix is from $\cos\varphi_1$ to $\cos\varphi_2$. So that the reactive strength necessities will alternate to:

$$Q_b = P.\tan\varphi_1$$

$$Q_t = P.\tan\varphi_2$$

So that

$$Q_c = Q_b - Q_t$$

$$C = \frac{Q_c}{2.\pi.f.V^2}$$

Where :

- Q_b = Reactive power before repair (KVAR)
- Q_t = Reactive power after repair (KVAR)
- Q_c = Compensated reactive power (KVAR)
- C = Capacitance Capacitor (μ F)

- Capacitor Bank Installation Location

In phrases of institution compensation, it's far was hoping that it may make amends for the reactive electricity to all engine buses withinside the carton manufacturing unit of PT. Intan Ustrix that allows you to boom the cost of $\cos\varphi$ toward 1 (0.99).

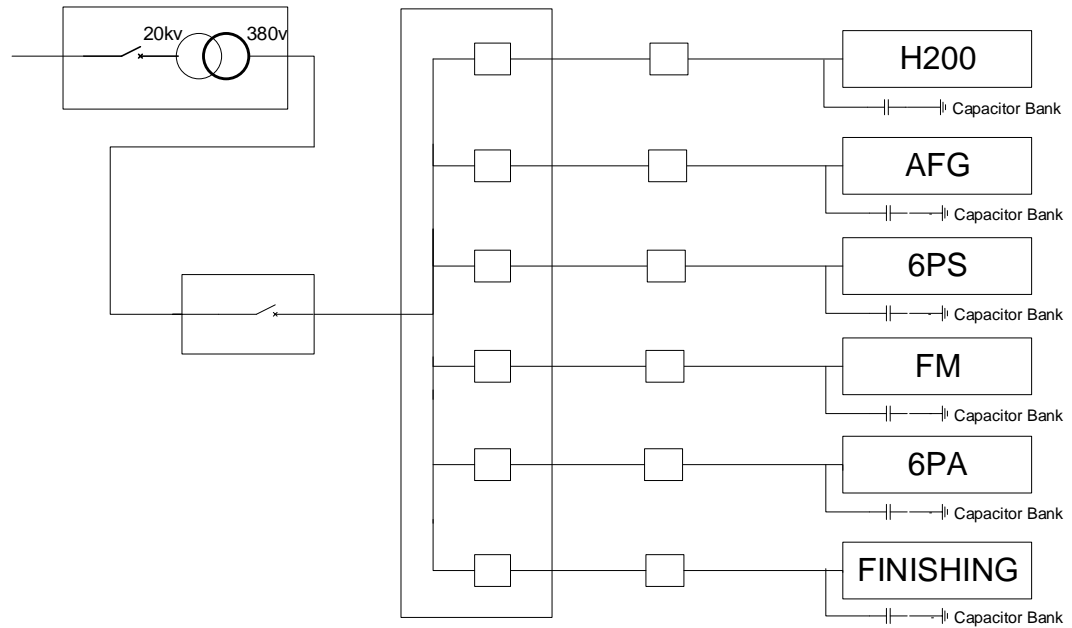

Figure 3. Capacitor Bank Design in Carton Production Unit of PT. Intan Ustrix

III. RESULTS AND DISCUSSIONS

A. Installation

Improve the electricity issue at PT. Intan Ustrix is achieved through putting in a capacitor financial institution on every cardboard manufacturing unit gadget bus [14]. This rationalization is observed through calculations and facts from calculations and simulations in Etap 7.0. The system received through calculating the electricity issue development indicates the effectiveness of the capacitor financial institution in growing the electricity issue and its impact on the electric device withinside the carton manufacturing unit.

B. Calculation

The H200 bus consists of several motor loads with different capacities.

Table 1. Existing Conditions H200 Simulation Results Before Capacitor Installation

Bus Name	S (KVA)	I (A)	Cos ϕ	ΔV (%)	P (KW)	Q (Kvar)
H200	245 KVA	380,3 A	0,8	96,38 %	196 KW	147 Kvar

Determine the voltage on the H200 line / bus:

$$\begin{aligned}
 VL &= V \times \Delta V \\
 &= 380 \times 96,38\% \\
 &= 366,244 \text{ V}
 \end{aligned}$$

Determining the S value (KVA) on the H200 bus:

$$\begin{aligned}
 S &= \frac{P}{\cos \phi} \\
 &= \frac{196}{0,802} = 245 \text{ kVA}
 \end{aligned}$$

Determine the nominal current value (A) on the H200 bus:

$$I_n = \frac{S}{\sqrt{3} \cdot V} = \frac{245}{\sqrt{3} \cdot 0,366} = 380,3 \text{ A}$$

Calculating the amount of KVAR on the capacitor bank that will be installed:

$$\cos \varphi_1 = 0,8 \rightarrow \varphi_1 = 36,86^\circ$$

$$\cos \varphi_2 = 0,99 \rightarrow \varphi_2 = 8,1^\circ$$

$$\begin{aligned} Q_c &= P (\tan \varphi_1 - \tan \varphi_2) \\ &= 196 (\tan 36,86^\circ - \tan 8,1^\circ) \\ &= 196 (0,75 - 0,142) \\ &= 196 \times 0,608 \\ &= 119,16 \text{ KVAR} \end{aligned}$$

$$\begin{aligned} C &= \frac{Q_c}{2 \cdot \pi \cdot f \cdot V^2} \\ &= \frac{119,16 \times 10^3}{2 \times 3,14 \times 50 \times 380^2} \\ &= 26,28 \times 10^{-4} \text{ F} \\ &= 2628 \mu\text{F} \end{aligned}$$

This value is used to simulate the installation of capacitor banks in Etap 7.0 on the H200 bus. From table 1 shows that the value of cos is 0.8, the total voltage is 96.38% with the power generated is 196 KW.

Table 2. Results of Comparison of Bus Conditions H200 Before and After Capacitor Installation

Bus H200	S (KVA)	I (A)	Cos φ	ΔV (%)	P (KW)	Q (Kvar)
Before	245 KVA	380,3 A	0,8	96,38%	196 KW	147 Kvar
After	197 KVA	302,7 A	0,987	98,06%	195 KW	32 Kvar

Determine the voltage on the H200 line / bus after installing the capacitor bank:

$$\begin{aligned} V_L &= V \times \Delta V \\ &= 380 \times 98,06\% \\ &= 372,62 \text{ V} \end{aligned}$$

Determining the S value (KVA) on the H200 bus:

$$\begin{aligned} S &= \frac{P}{\cos \varphi} \\ &= \frac{196}{0,987} = 198,5 \text{ kVA} \end{aligned}$$

Determine the nominal current value (A) on the H200 bus:

$$\begin{aligned} I_n &= \frac{S}{\sqrt{3} \cdot V} \\ &= \frac{197}{\sqrt{3} \cdot 0,373} = 305,2 \text{ A} \end{aligned}$$

From table 2 shows that the value of cos is 0.8, the total voltage is 96.38% with the power generated is 196 KW and after condition that the value of cos is 0.987, the total voltage is 98.06% with the power generated is 195 KW. As an evaluation, capacitor banks are installed on the H200, AFG, 6PA, FM and 6PS buses so that low cos costs can be increased. The final final result of this charge shows that increasing the cos, the lower the current consumption price of the motor used can increase the resistance of the device to the carton production unit.

Table 3. Comparison Results Before And After Installing Capacitor Banks In Cardboard Production Units

Bus Name	BEFORE INSTALLING CAPACITOR					
	S (KVA)	I (A)	Cos ϕ	ΔV (%)	P (KW)	Q (Kvar)
H200	245 KVA	380,3 A	0,8	96,38%	196 KW	147 Kvar
AFG	20 KVA	31,2 A	0,801	97,49%	16 KW	12 Kvar
6PS	17 KVA	26,3 A	0,8	97,62%	14 KW	10 Kvar
FM	9 KVA	14,4 A	0,8	97,62%	7 KW	6 Kvar
6PA	44 KVA	68,2 A	0,801	97,54%	35 KW	26 Kvar
FINISHING	18 KVA	28 A	0,8	97,66%	14 KW	11 Kvar
Carton Production Unit	376 KVA	584 A	0,826	97,72%	310 KW	212 Kvar
Bus Name	AFTER INSTALLING CAPACITOR					
	S (KVA)	I (A)	Cos ϕ	ΔV (%)	P (KW)	Q (Kvar)
H200	197 KVA	302,7 A	0,987	98,06%	195 KW	32 Kvar
AFG	16 KVA	24,9 A	0,987	98,78%	16 KW	3 Kvar
6PS	14 KVA	20,9 A	0,991	98,9%	14 KW	2 Kvar
FM	8 KVA	11,6 A	0,983	98,9%	7 KW	1 Kvar
6PA	35 KVA	54,4 A	0,988	98,82%	35 KW	6 Kvar
FINISHING	15 KVA	22,4 A	0,986	98,93%	14 KW	2 Kvar
Carton Production Unit	313 KVA	481 A	0,989	98,98%	310 KW	45 Kvar

From Table 3, the set up of capacitor banks to the electric system, it could be visible in Table three that the feature of the capacitor is to boom the electricity component or $\cos \phi$, lower the price of S (KVA), lower the price of the modern-day and catch up on the reactive electricity Q (Kvar).

Improve the electricity issue at PT. Intan Ustrix is achieved through putting in a capacitor financial institution on every cardboard manufacturing unit gadget bus [15]. This rationalization is observed through calculations and facts from calculations and simulations in Etap 7.0 [16]. The system received through calculating the electricity issue development indicates the effectiveness of the capacitor financial institution in growing the electricity issue and its impact on the electric device withinside the carton manufacturing unit.

Static consisting of temperature versions and susceptible grids with excessive quantities of harmonic voltages. SVGs also are extra appropriate for hastily various loads. A capacitor financial institution isn't always able to correcting the Power Factor of capacitive loads, while an SVG is capable of do this. The primary downside of an SVG is, of course, the better cost.

The function of a Cos Phi capacitor financial institution by installing a Cos Phi capacitor financial institution reduces ate-up reactive electricity. The capacitor financial institution presents capacitive electricity to catch up on the inductive electricity (reactive electricity). As a result, the reactive electricity does now no longer skips via the complete setup. Energy losses withinside the setup are significantly decreased, and electricity performance is improved.

The proper kind and capacity is different forms of Cos Phi capacitor financial institution (regulated and fixed) are available, with dozens of various capacities. Each set up and scenario calls for accurate

evaluation and calculation, so as to size the maximum appropriate capacitor financial institution. HyTEPS has enormous understanding and years of experience, permitting us to recommend you. We deliver a extensive variety of notable Cos Phi capacitor banks from numerous notable suppliers.

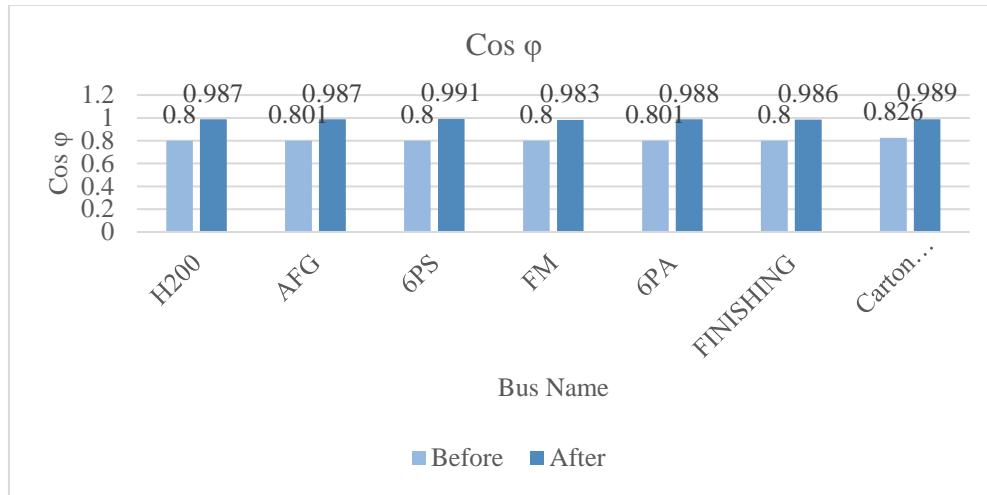

Figure 4. Value Increase $\text{Cos } \phi$

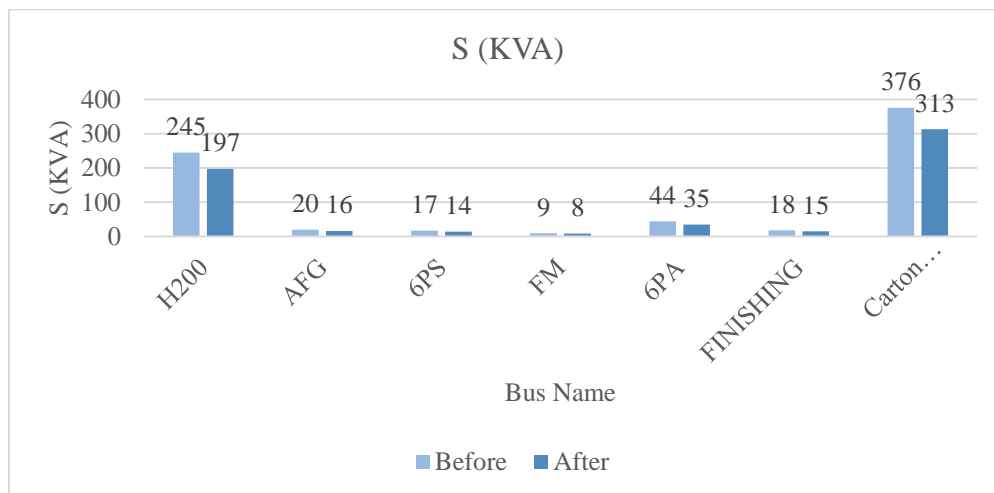

Figure 5. Impairment KVA

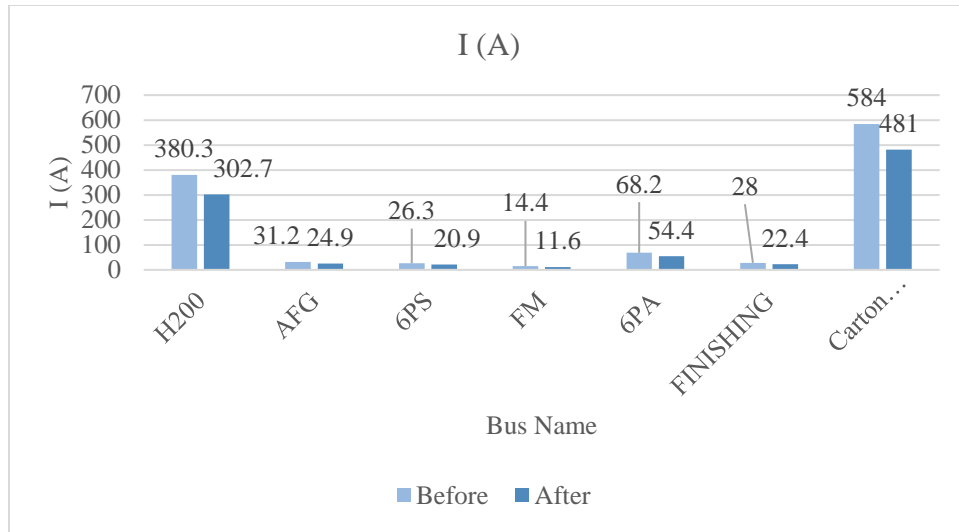

Figure 6. Decreasing Current Value

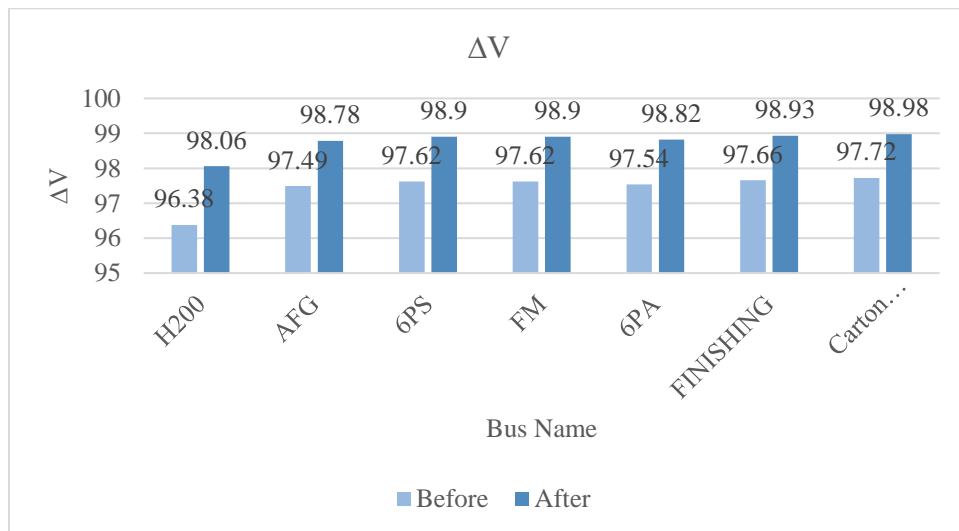

Figure 7. Percentage Delta V

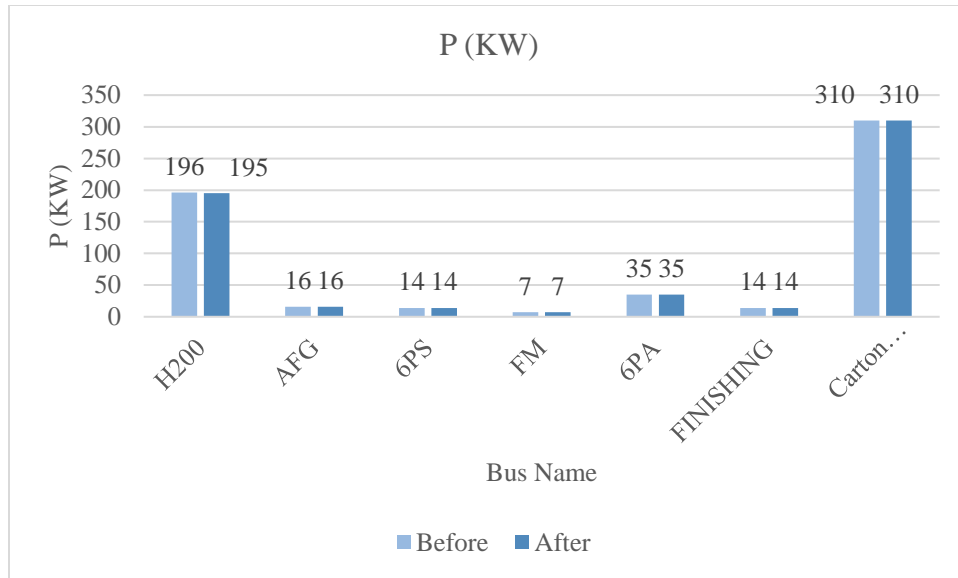

Figure 8. Power Value Comparison

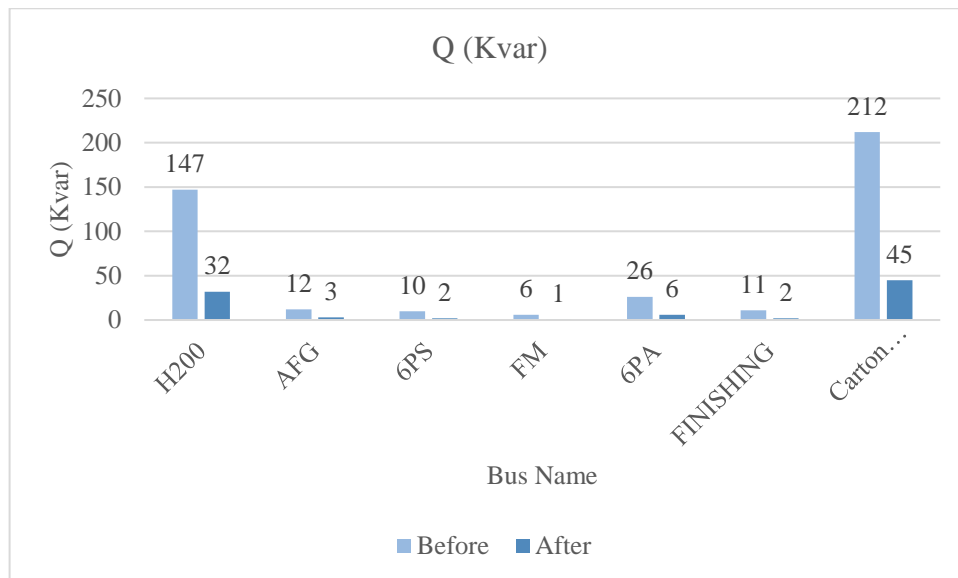

Figure 9. Value Comparison Q(Kvar)

In Figure 4 to Figure 9, can be seen the results of comparisons before and after the installation of the Capacitor Bank to the electrical system, and it can be seen that there has been a decrease in apparent power (Figure 5), Reactive power (Figure 9), Current Value (Figure 6), and Repair. Power Factor Value (Figure 4). The dialogue of the effect of putting in capacitor banks on every bus in a carton manufacturing unit might be defined as follows:

Installing a 119.16 KVAR capacitor bank on the H200 bus increases the $\cos \phi$ value to 0.987, the S value decreases by 48 KVA, the current decreases by 77.6 A, the Voltage Loss decreases by 1.68% and the compensated Reactive Power is 115 KVAR. Installing a capacitor bank of 9.68 KVAR on the AFG bus increases the $\cos \phi$ value to 0.987, decreases the S value by 4 KVA, the current decreases by 6.3 A, the Voltage Loss decreases by 1.29% and the compensated Reactive Power is 9 KVAR.

Installing a capacitor bank of 8,512 KVAR on a 6PS bus increases the $\cos \phi$ value to 0.991, decreases the S value by 3 KVA, decreases the current by 5.4 A, reduces Voltage Loss by 1.28% and compensates for Reactive Power by 8 KVAR.

Installing a capacitor bank of 4.256 KVAR on the FM bus increases the $\cos \phi$ value to 0.983, decreases the value of S by 1 KVA, decreases in current by 2.8 A, decreases Voltage Loss by 1.28% and compensates for Reactive Power by 5 KVAR.

Installing a capacitor bank of 21.175 KVAR on the 6PA bus increases the $\cos \phi$ value to 0.988, decreases the S value by 9 KVA, decreases the current by 13.8 A, decreases Voltage Loss by 1.28% and compensates for Reactive Power by 20 KVAR. Installing a capacitor bank of 8,512 KVAR on the FINISHING bus increases the value of $\cos \phi$ to 0.986, decreases the value of S by 3 KVA, decreases in current by 5.6 A, decreases Voltage Loss by 1.27% and compensates for Reactive Power by 9 KVAR.

Installing capacitor banks on each bus in the carton production unit of PT. Intan Ustrix can increase the $\cos \phi$ value to 0.989, decrease the S value by 63 KVA, decrease the current by 103 A, reduce the Voltage Loss by 1.26% and compensate for Reactive Power by 167 KVAR.

IV. CONCLUSIONS AND RECOMMENDATIONS

Due to the location of the Power Factor correction tool, the positioning of the correction tool is of crucial significance in accomplishing your goals. Reactive energy may be compensated decentrally. The major gain of this approach is the reality that no cutting-edge reactive flows via the feeding lines. This prevents excessive cable losses in massive disbursed installations. Reactive energy also can be compensated centrally. This may be carried out at the medium voltage grid, introducing the gain of scale.

Based on the effects of the discussion, the subsequent conclusions may be drawn: Installing capacitor banks withinside the electric device of the manufacturing unit of PT. Intan Ustrix can boom the price of $\cos \phi$, the whole load of 310 KW from 0.826 to 0.989 and decrease the cost of lively power (S) from 376 KVA to 313 KVA, that could shop sixty-three KVA and decrease the cost of cutting-edge (I) from 584 A to 481 A, so that the sturdiness of the system withinside the carton manufacturing unit may be improved because of a lower withinside the cutting-edge intake price of the motor used.

V. REFERENCES

- [1] A. Darwanto, "Perbaikan Faktor Daya Workshop Teknik Mesin Menggunakan Bank Kapasitor Siemens 2, 5 Kvar Berbasis Power Faktor Regulator," *SIMETRIS*, no. 13, 2013.
- [2] S. W. Habsoro, A. Nugroho, and B. Winardi, "Analisa Penempatan Kapasitor Bank Untuk Perhitungan Drop Voltage Pada Feeder Batang 02 Tahun 2012-2016 dengan Software Etap 7.0. 0," *Transient J. Ilm. Tek. Elektro*, vol. 2, no. 1, pp. 16–23, 2013.
- [3] M. F. Hakim, "Analisis kebutuhan capacitor bank beserta implementasinya untuk memperbaiki faktor daya listrik di politeknik kota malang," *J. Eltek*, vol. 12, no. 1, pp. 105–118, 2017.
- [4] A. T. Nugraha and L. N. Safitri, "Optimization of Central Air Conditioning Plant by Scheduling the Chiller Ignition for Chiller Electrical Energy Management," *Indones. J. Electron. Electromed. Eng. Med. informatics*, vol. 3, no. 2, pp. 76–83, 2021.
- [5] A. T. Nugraha and D. Priyambodo, "Design of Pond Water Turbidity Monitoring System in Arduino-based Catfish Cultivation to Support Sustainable Development Goals 2030 No. 9 Industry, Innovation, and Infrastructure," *J. Electron. Electromed. Eng. Med. Informatics*, vol. 2, no. 3, pp. 119–124, 2020.
- [6] J. S. Setiadji, T. Machmudsyah, and R. Kongdoro, "Analisa Gangguan Satu Fasa ke Tanah yang Mengakibatkan Sympathetic Trip pada Penyulang yang tidak Terganggu di PLN APJ Surabaya Selatan," *J. Tek. Elektro*, vol. 6, no. 1, 2006.
- [7] S. Ngubel, "Studi penggunaan directional ground relay (DGR) pada penyulang Kebomas gardu induk (GI) Petrokimia, PLN UPJ area Gresik." Petra Christian University, 2003.
- [8] T. Yuwono and A. Sjamjul, *Peralatan Tegangan Tinggi*. Institut Teknologi Sepuluh Nopember Surabaya, 1999.
- [9] V. Poulek and M. Libra, "A very simple solar tracker for space and terrestrial applications," *Sol. Energy Mater. Sol. Cells*, vol. 60, no. 2, pp. 99–103, 2000.
- [10] A. T. Nugraha and D. Priyambodo, "Design of a Monitoring System for Hydroganics based on Arduino Uno R3 to Realize Sustainable Development Goals number 2 Zero Hunger," *J. Electron. Electromed. Eng. Med. Informatics*, vol. 3, no. 1, pp. 50–56, 2021.
- [11] F. Afifudin and F. S. Hananto, "Optimalisasi Tegangan Keluaran Dari Solar Cell Menggunakan Lensa Pemfokus Cahaya Matahari," *J. Neutrino J. Fis. dan Apl.*, 2012.

- [12] E. B. Raharjo, S. Sumardi, and I. Setiawan, "SISTEM KENDALI PENJEJAK SINAR MATAHARI MENGGUNAKAN MIKROKONTROLER ATMEGA8535." Jurusan Teknik Elektro Fakultas Teknik Undip, 2011.
- [13] "ACS712 Module Measures Currents up to 30A for as Low as \$1 Shipped - CNX Software." <https://www.cnx-software.com/2016/01/23/acs712-module-measures-currents-30a-1-dollar/> (accessed Jul. 31, 2021).
- [14] A. T. Nugraha and D. Priyambodo, "Development of Rocket Telemetry in Chamber Gas Pressure Monitoring with the MPXV7002DP Gas Pressure Sensor," *J. Electron. Electromed. Eng. Med. Informatics*, vol. 2, no. 3, pp. 103–107, 2020.